

SAMSUNG harman/kardon®

FULL MANUAL

HW-Q70R

Imagine the possibilities

Thank you for purchasing this Samsung product.

To receive more complete service, please register
your product at www.samsung.com/register

SAFETY INFORMATION









SAFETY WARNINGS

TO REDUCE THE RISK OF ELECTRIC SHOCK, DO NOT REMOVE THE COVER (OR BACK).

NO USER-SERVICEABLE PARTS ARE INSIDE.

REFER SERVICING TO QUALIFIED SERVICE PERSONNEL.

Refer to the table below for an explanation of symbols which may be on your Samsung product.

	<p style="text-align: center;">CAUTION RISK OF ELECTRIC SHOCK. DO NOT OPEN.</p>	
	<p>This symbol indicates that high voltage is present inside. It is dangerous to make any kind of contact with any internal part of this product.</p>	
	<p>This symbol indicates that this product has included important literature concerning operation and maintenance.</p>	
	<p>Class II product : This symbol indicates that it does not require a safety connection to electrical earth (ground). If this symbol is not present on a product with a power cord, the product MUST have a reliable connection to protective earth (ground).</p>	
	<p>AC voltage : This symbol indicates that the rated voltage marked with the symbol is AC voltage.</p>	
	<p>DC voltage : This symbol indicates that the rated voltage marked with the symbol is DC voltage.</p>	
	<p>Caution, Consult instructions for use : This symbol instructs the user to consult the user manual for further safety related information.</p>	

WARNING

- To reduce the risk of fire or electric shock, do not expose this appliance to rain or moisture.

CAUTION

- TO PREVENT ELECTRIC SHOCK, MATCH WIDE BLADE OF PLUG TO WIDE SLOT, FULLY INSERT.
- This apparatus shall always be connected to a AC outlet with a protective grounding connection.
- To disconnect the apparatus from the mains, the plug must be pulled out from the mains socket, therefore the mains plug shall be readily operable.
- Do not expose this apparatus to dripping or splashing. Do not put objects filled with liquids, such as vases on the apparatus.
- To turn this apparatus off completely, you must pull the power plug out of the wall socket. Consequently, the power plug must be easily and readily accessible at all times.

PRECAUTIONS

1. Ensure that the AC power supply in your house complies with the power requirements listed on the identification sticker located on the bottom of your product. Install your product horizontally, on a suitable base (furniture), with enough space around it for ventilation (7~10 cm). Make sure the ventilation slots are not covered. Do not place the unit on amplifiers or other equipment which may become hot. This unit is designed for continuous use. To fully turn off the unit, disconnect the AC plug from the wall outlet. Unplug the unit if you intend to leave it unused for a long period of time.
2. During thunderstorms, disconnect the AC plug from the wall outlet. Voltage peaks due to lightning could damage the unit.
3. Do not expose the unit to direct sunlight or other heat sources. This could lead to overheating and cause the unit to malfunction.
4. Protect the product from moisture (i.e. vases), and excess heat (e.g. a fireplace) or equipment creating strong magnetic or electric fields. Unplug the power cable from the AC wall socket if the unit malfunctions. Your product is not intended for industrial use. It is for personal use only. Condensation may occur if your product has been stored in cold temperatures. If transporting the unit during the winter, wait approximately 2 hours until the unit has reached room temperature before using.

5. The battery used with this product contains chemicals that are harmful to the environment. Do not dispose of the battery in the general household trash. Do not expose the battery to excess heat, direct sunlight, or fire. Do not short circuit, disassemble, or overheat the battery. Danger of explosion if the battery is replaced incorrectly. Replace only with the same or equivalent type.

ABOUT THIS MANUAL

The user manual has two parts: this simple paper USER MANUAL and a detailed FULL MANUAL you can download.



USER MANUAL

See this manual for safety instructions, product installation, components, connections, and product specifications.



FULL MANUAL

You can access the FULL MANUAL on Samsung's on-line customer support centre by scanning the QR code. To see the manual on your PC or mobile device, download the manual in document format from Samsung's website. (<http://www.samsung.com/support>)

Design, specifications, and App screen are subject to change without prior notice.

CONTENTS

01	Checking the Components	2
	Inserting Batteries before using the Remote Control (AA batteries X 2)	2
02	Product Overview	3
	Front Panel / Right Side Panel of the Soundbar	3
	Bottom Panel of the Soundbar	4
03	Connecting the Soundbar	5
	Connecting Electrical Power	5
	Connecting the Soundbar to the Subwoofer	6
	– Automatic connection between the Subwoofer and the Soundbar	6
	– Manually connecting the Subwoofer if automatic connection fails	7
	Connecting an SWA-8500S (Sold Separately) to your Soundbar	8
04	Connecting to your TV	10
	Method 1. Connecting with a Cable	10
	– Connecting a TV using an HDMI Cable	10
	– Connecting using an Optical Cable	11
	Method 2. Connecting Wirelessly	12
	– Connecting a TV via Bluetooth	12
	– Connecting via Wi-Fi	14
05	Connecting an External Device	16
	Connecting using an HDMI Cable (Capable of Dolby Atmos decoding and playback)	16
	Connecting using an HDMI Cable	17
	Connecting using an Optical Cable	18
06	Connecting a Mobile Device	19
	Connecting via Bluetooth	19
	Connecting via Wi-Fi (Wireless Network)	22

07	Connecting an Amazon product	24
	Connect and use with an Amazon product (Amazon Echo)	24
	Use voice commands to control the Soundbar	26
08	Using the Remote Control	27
	How to Use the Remote Control	27
	Adjusting the Soundbar volume with a TV remote control	30
	Using the Hidden Buttons (Buttons with more than one function)	31
	Output specifications for the different sound effect modes	31
09	Installing the Wall Mount	32
	Installation Precautions	32
	Wallmount Components	32
10	Installing the Holder-Feet	34
	Holder-Feet Components	34
11	Software Update	35
12	Troubleshooting	36
13	Licence	37
14	Open Source Licence Notice	38
15	Important Notes About Service	38
16	Specifications and Guide	39
	Specifications	39

01 CHECKING THE COMPONENTS

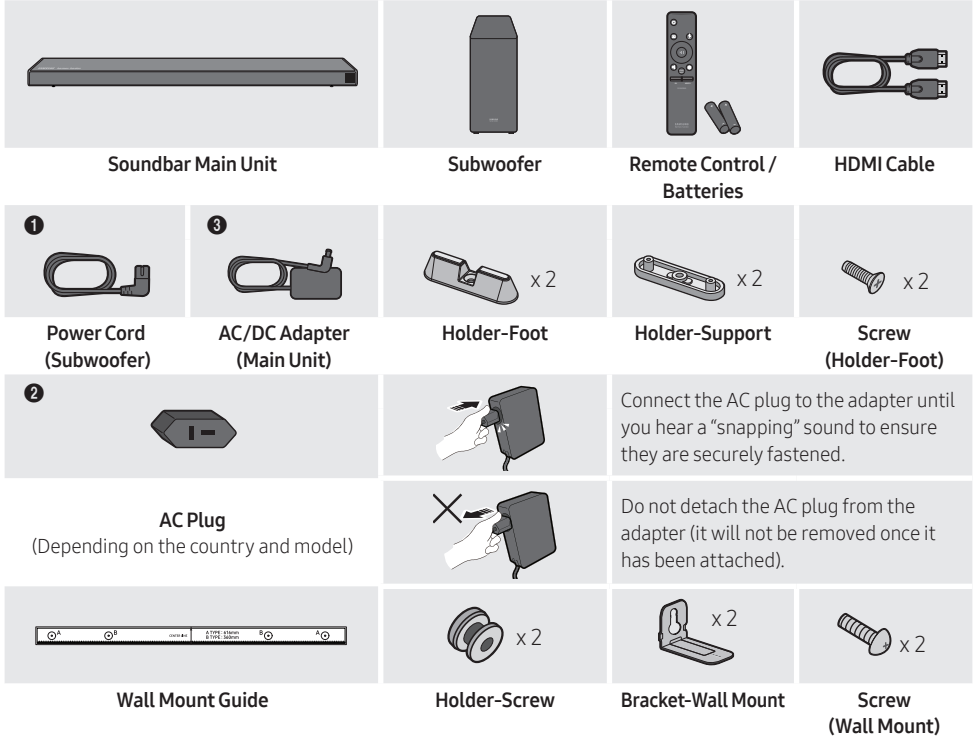

- For more information about the power supply and power consumption, refer to the label attached to the product. (Label: Bottom of the Soundbar Main Unit)
- The power components are labelled (1, 2, 3). For more information about power connections, see page 5.
- To purchase additional components or optional cables, contact a Samsung Service Centre or Samsung Customer Care.
- Depending on the region, the appearance of the AC plug may differ from the plug displayed above, or it may be supplied integrated with the AC/DC adapter.
- The appearance of the accessories may differ slightly from the illustrations above.

Inserting Batteries before using the Remote Control (AA batteries X 2)

Slide the battery cover in the direction of the arrow until it is completely removed. Insert 2 AA batteries (1.5V) oriented so that their polarity is correct. Slide the battery cover back into position.

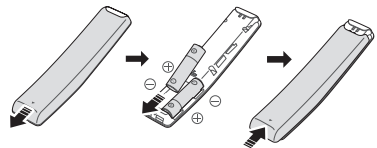

02 PRODUCT OVERVIEW

Front Panel / Right Side Panel of the Soundbar

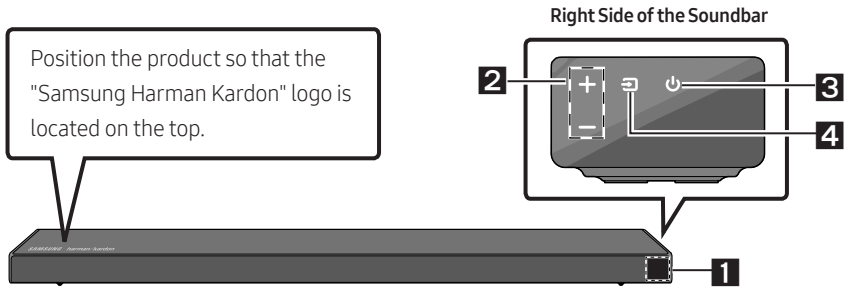

1	<p>Display Displays the product's status and current mode.</p>												
2	<p>+/- (Volume) Button Adjusts the volume.</p> <ul style="list-style-type: none"> When adjusted, the volume level appears on the Soundbar's front display. 												
3	<p>⏻ (Power) Button Turns the power on and off.</p> <ul style="list-style-type: none"> Auto Power Down Function The unit turns off automatically in the following situations: <ul style="list-style-type: none"> In D.IN / HDMI / WIFI / BT mode if there is no audio signal for 18 minutes. 												
4	<p>🔍 (Source) Button Selects the source input mode.</p> <table border="1" style="width: 100%; border-collapse: collapse;"> <thead> <tr> <th style="text-align: center;">Input mode</th> <th style="text-align: center;">Display</th> </tr> </thead> <tbody> <tr> <td style="text-align: center;">Optical Digital input</td> <td style="text-align: center;">D.IN</td> </tr> <tr> <td style="text-align: center;">ARC (HDMI OUT) input</td> <td style="text-align: center;">D.IN → TV ARC (Auto conversion)</td> </tr> <tr> <td style="text-align: center;">HDMI input</td> <td style="text-align: center;">HDMI</td> </tr> <tr> <td style="text-align: center;">Wi-Fi mode</td> <td style="text-align: center;">WIFI</td> </tr> <tr> <td style="text-align: center;">BLUETOOTH mode</td> <td style="text-align: center;">BT</td> </tr> </tbody> </table>	Input mode	Display	Optical Digital input	D.IN	ARC (HDMI OUT) input	D.IN → TV ARC (Auto conversion)	HDMI input	HDMI	Wi-Fi mode	WIFI	BLUETOOTH mode	BT
Input mode	Display												
Optical Digital input	D.IN												
ARC (HDMI OUT) input	D.IN → TV ARC (Auto conversion)												
HDMI input	HDMI												
Wi-Fi mode	WIFI												
BLUETOOTH mode	BT												

- When you plug in the AC cord, the power button will begin working in 4 to 6 seconds.
- When you turn on this unit, there will be a 4 to 5 second delay before it produces sound.
- If you want to enjoy sound only from the Soundbar, you must turn off the TV's speakers in the Audio Setup menu of your TV. Refer to the owner's manual supplied with your TV.

Bottom Panel of the Soundbar

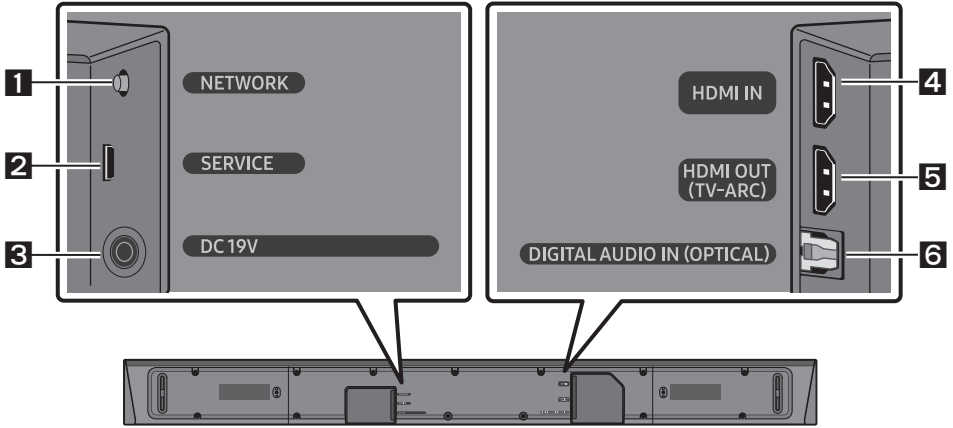

1	NETWORK Press to connect to a wireless network (Wi-Fi) via the SmartThings app.
2	SERVICE Connect a USB storage device to upgrade the product's software.
3	DC 19V (Power Supply In) Connect the AC/DC power adaptor.
4	HDMI IN Inputs digital video and audio signals simultaneously using an HDMI cable. Connect to the HDMI output of an external device.
5	HDMI OUT (TV-ARC) Connect to the HDMI (ARC) jack on a TV.
6	DIGITAL AUDIO IN (OPTICAL) Connect to the digital (optical) output of an external device.

- When disconnecting the power cable of the AC/DC power adaptor from a wall outlet, pull the plug. Do not pull the cable.
- Do not connect this unit or other components to an AC outlet until all connections between components are complete.

03 CONNECTING THE SOUNDBAR

Connecting Electrical Power

Use the power components (❶, ❷, ❸) to connect the Subwoofer and Soundbar to an electrical outlet in the following order:

- ❶ Connect the power cord to the Subwoofer.
- ❷ Connect the AC plug to the adapter.
- ❸ Connect the power adapter to the Soundbar and then to a wall socket.

See the illustrations below.

- For more information about the required electrical power and power consumption, refer to the label attached to the product. (Label: Bottom of the Soundbar Main Unit)

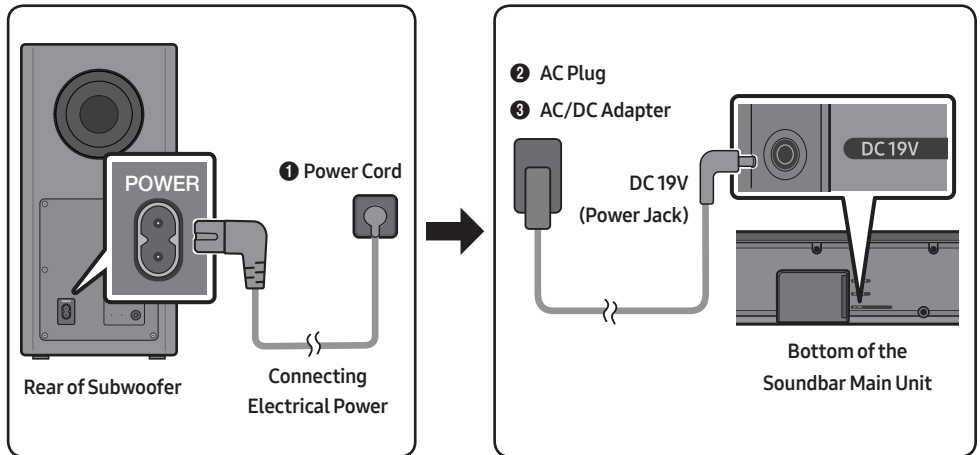

Connecting the Soundbar to the Subwoofer

When the subwoofer is connected, you can enjoy rich bass sound.

Automatic connection between the Subwoofer and the Soundbar

When you turn the power on after connecting the power cables to the Soundbar and subwoofer, the subwoofer is automatically connected to the Soundbar.

- When auto pairing is complete, the blue indicators at the rear of the subwoofer turn on.

LED Indicator Lights on the Rear of Subwoofer

LED	Status	Description	Resolution
Blue	On	Successfully connected (normal operation)	-
	Blinking	Recovering the connection	Check if the power cable attached to the main Soundbar unit is connected properly or wait about 5 minutes. If blinking persists, try manually connecting the subwoofer. See page 7.
Red	On	Standby (with the Soundbar main unit turned off)	Check if the power cable attached to the main Soundbar unit is connected properly.
		Connection failed	Connect again. See the instructions for manual connection on page 7.
Red and blue	Blinking	Malfunction	See the contact information for the Samsung Service Centre in this manual.

Manually connecting the Subwoofer if automatic connection fails

Before performing the manual connection procedure below:

- Check whether the power cables for the Soundbar and subwoofer are connected properly.
- Make sure that the Soundbar is turned on.

1. Press and hold **ID SET** on the rear of the subwoofer for at least 5 seconds.
 - The red indicator on the rear of the subwoofer turns off and the blue indicator blinks.

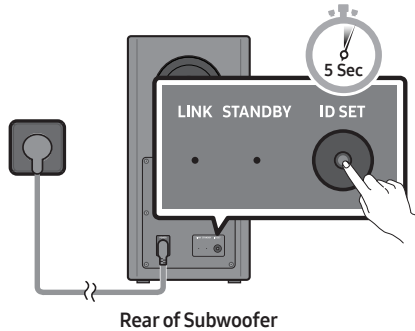

2. Press and hold the **Up** button on the remote control for at least 5 seconds.
 - The **ID SET** message appears on the display of the Soundbar for a moment, and then it disappears.
 - The Soundbar will automatically power on when **ID SET** is complete.

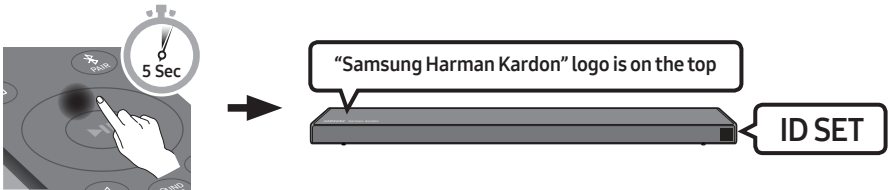

3. Check if the LINK LED is solid blue (connection complete).

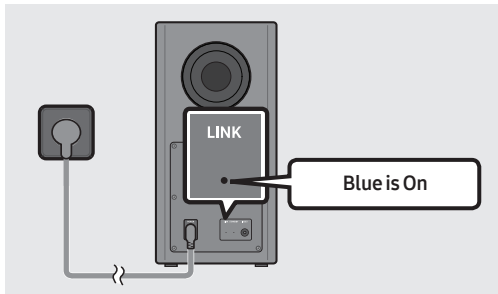

The LINK LED indicator stops blinking and glows a solid blue when a connection is established between the Soundbar and the Wireless Subwoofer.

NOTES

- Do not connect the power cord of this product or your TV to a wall outlet until all connections between components are complete.
- Before moving or installing this product, be sure to turn off the power and disconnect the power cord.
- If the main unit is powered off, the wireless subwoofer will go into stand-by mode and the STANDBY LED on the rear of the sub-woofer will turn red after blinking in blue several times.
- If you use a device that uses the same frequency (5.8GHz) as the Soundbar near the Soundbar, interference may cause some sound interruption.
- The maximum transmission distance of the main unit's wireless signal is about 10 meters, but may vary depending on your operating environment. If a steel-concrete or metallic wall is between the main unit and the wireless subwoofer, the system may not operate at all because the wireless signal cannot penetrate metal.

PRECAUTIONS

- Wireless receiving antennas are built into the wireless subwoofer. Keep the unit away from water and moisture.
- For optimal listening performance, make sure that the area around the wireless subwoofer and the Wireless Receiver Module (sold separately) is clear of any obstructions.

Connecting an SWA-8500S (Sold Separately) to your Soundbar

Expand to true wireless surround sound by connecting the Samsung Wireless Rear Speaker Kit (SWA-8500S, sold separately) to your Soundbar.

1. Connect the Wireless Receiver Module to 2 Surround Speakers.
 - The speaker cables are colour coded.

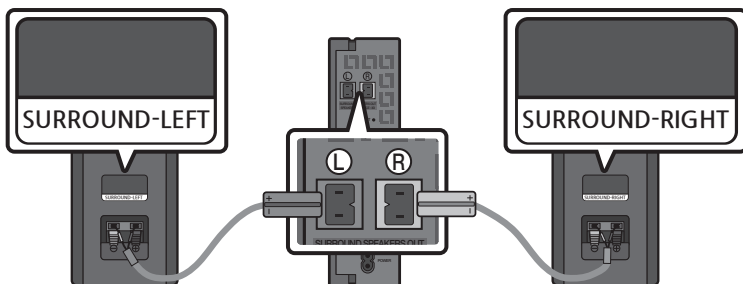

2. Check the standby status of the Wireless Receiver Module after plugging it into an electrical outlet.
 - The LINK LED indicator (blue LED) on the Wireless Receiver Module blinks. If the LED does not blink, press the **ID SET** button on the back of the Wireless Receiver Module with a pen tip for 5~6 seconds until the LINK LED indicator blinks (in Blue). For more about the LED, please refer to the SWA-8500S user manual.

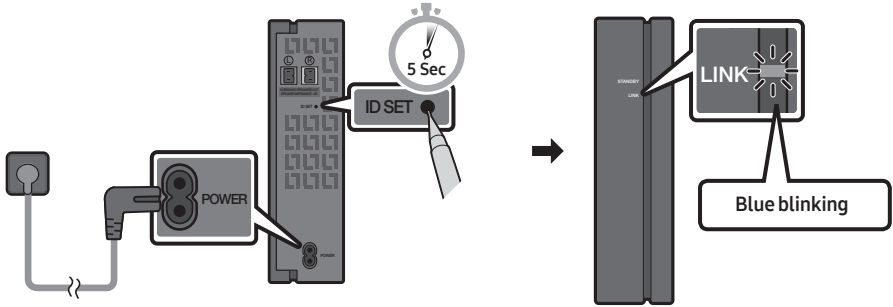

3. Press and hold the **Up** button on the remote control for at least 5 seconds.
 - The **ID SET** message appears on the display of the Soundbar for a moment, and then it disappears.
 - The Soundbar will automatically power on when **ID SET** is complete.

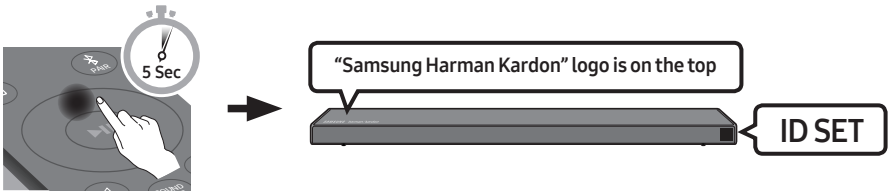

⚠ CAUTION

- If your Soundbar was playing music when it connects to the SWA-8500S, you may hear some stuttering from the woofer as the connection finalises.

4. Check if the LINK LED is solid blue (connection complete).

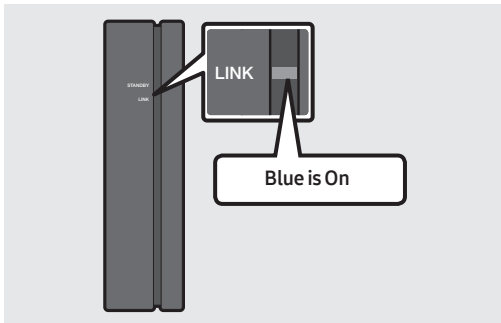

The LINK LED indicator stops blinking and glows a solid blue when a connection is established between the Soundbar and the Wireless Receiver Module.

5. If the SWA-8500S is not connected, repeat the procedure from Step 2.

04 CONNECTING TO YOUR TV

Hear TV sound from your Soundbar through wired or wireless connections.

- When the Soundbar is connected to selected Samsung TVs, the Soundbar can be controlled using the TV's remote control.
 - This feature is available on 2017 and later Samsung Smart TVs that support Bluetooth when the Soundbar is connected to the TV using an optical cable.
 - This function also allows you to use the TV menu to adjust the sound field and various settings as well as the volume and mute.

Method 1. Connecting with a Cable

When the audio in a broadcast is encoded in Dolby Digital and the “Digital Output Audio Format” on your TV is set to PCM, we recommend that you change the setting to Dolby Digital. When the setting on the TV is changed, you will experience better sound quality. (The TV menu may use different words for Dolby Digital and PCM depending on the TV manufacturer.)

Connecting a TV using an HDMI Cable

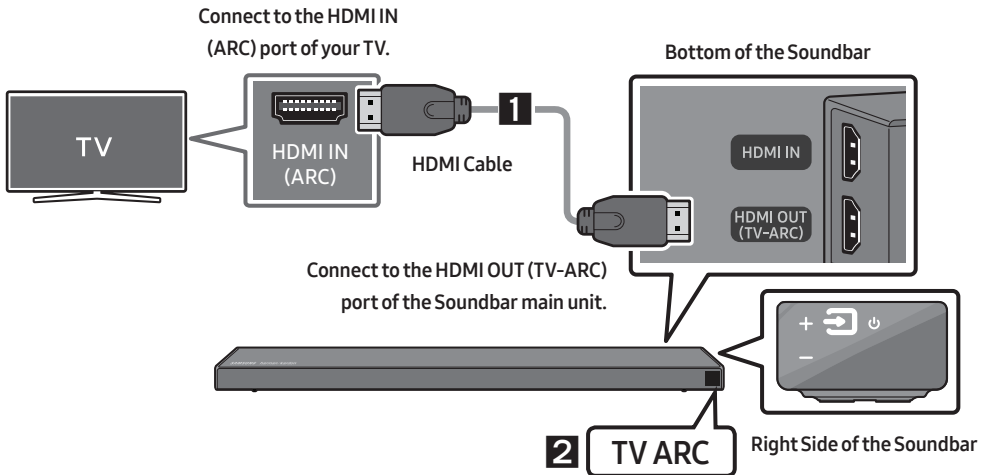

1. With the Soundbar and TV turned on, connect the HDMI cable as shown in the figure.
2. “TV ARC” appears in the display window of the Soundbar main unit and the Soundbar plays TV sound.
 - If TV sound is inaudible, press the  (Source) button on the remote control or on the right side of the Soundbar to switch to “D.IN” mode. The screen displays “D.IN” and “TV ARC” in sequence, and TV sound is played.

- If “**TV ARC**” does not appear in the display window of the Soundbar main unit, confirm that the HDMI cable is connected to the correct port.
- Use the volume buttons on the TV’s remote control to change the volume on the Soundbar.

NOTES

- HDMI is an interface that enables the digital transmission of video and audio data with just a single connector.
- If the TV provides an ARC port, connect the HDMI cable to the HDMI IN (ARC) port.
- We recommend you use a coreless HDMI cable if possible. If you use a cored HDMI cable, use one whose diameter is less than 14 mm.
- Anynet+ must be turned on.
- This function is not available if the HDMI cable does not support ARC.

Connecting using an Optical Cable

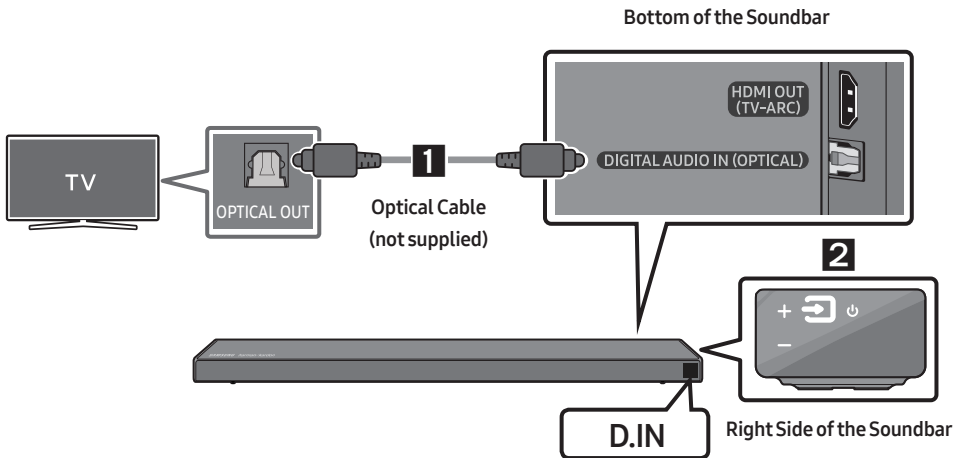

1. Connect the **DIGITAL AUDIO IN (OPTICAL)** jack on the Soundbar to the **OPTICAL OUT** jack of the TV with a digital optical cable (not supplied).
2. Press the  (**Source**) button on the right side panel or remote control, and then select the “**D.IN**” mode.

Auto Power Link

Auto Power Link automatically turns on the Soundbar when the TV is turned on.

1. Connect the Soundbar and a TV with a digital optical cable (not supplied).
2. Press the **Left** button on the remote control for 5 seconds to turn Auto Power Link on or off.
 - Auto Power Link is set to ON by default.
(To turn off this function, press the **Left** button on the remote for 5 seconds.)
 - Depending on the connected device, Auto Power Link may not function.
 - This function is only available in the **"D.IN"** mode.



Method 2. Connecting Wirelessly

Connecting a TV via Bluetooth

When a TV is connected using Bluetooth, you can hear stereo sound without the hassle of cabling.

- Only one TV can be connected at a time.

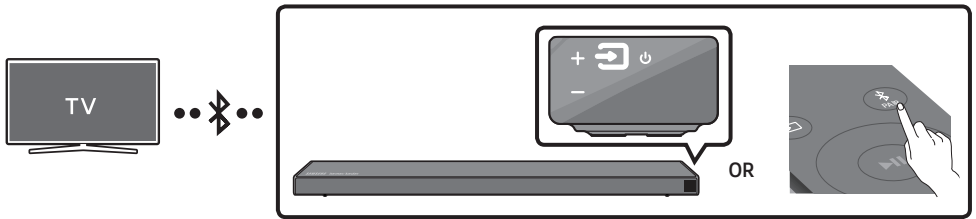

The initial connection

1. Press the **PAIR** button on the remote control to enter the **"BT PAIRING"** mode.
(OR) a. Press the **(Source)** button on the right side panel and then select **"BT"**.
"BT" changes to **"BT READY"** in a few seconds automatically if there is no Bluetooth device connected to the Soundbar.
b. When **"BT READY"** appears, press and hold the **(Source)** button on the right side panel of the Soundbar for more than 5 seconds to display **"BT PAIRING"**.
2. Select Bluetooth mode on the TV. (For more information, see the TV's manual.)
3. Select **"[AV] Samsung Soundbar Q70R"** from the list on TV's screen.
An available Soundbar is indicated with **"Need Pairing"** or **"Paired"** on the TV's Bluetooth device list. To connect the TV to the Soundbar, select the message, and then establish a connection.
 - When the TV is connected, **[TV Name]** → **"BT"** appears on the Soundbar's front display.
4. You can now hear TV sound from the Soundbar.

If the device fails to connect

- If a previously connected Soundbar (e.g. “[AV] Samsung Soundbar Q70R”) appears in the list, delete it.
- Then repeat steps 1 through 3.

NOTE



- After you have connected the Soundbar to your TV the first time, use the “**BT READY**” mode to reconnect.

Disconnecting the Soundbar from the TV

Press the  (**Source**) button on the right side panel or on the remote control and switch to any mode but “**BT**”.

- Disconnecting takes time because the TV must receive a response from the Soundbar. (The time required may differ, depending on the TV model.)
- To cancel the automatic Bluetooth connection between the Soundbar and TV, press the **▶II (Play/Pause)** button on the remote control for 5 seconds with the Soundbar in “**BT READY**” status. (Toggle On → Off)

What is the difference between BT READY and BT PAIRING?

- **BT READY** : In this mode, you can search for previously connected TVs or connect a previously connected mobile device to the Soundbar.
- **BT PAIRING** : In this mode, you can connect a new device to the Soundbar. (Press the  **PAIR** button on the remote control or press and hold the  (**Source**) button on the right side of the Soundbar for more than 5 seconds while the Soundbar is in “**BT**” mode.)

NOTES

- If asked for a PIN code when connecting a Bluetooth device, enter <0000>.
- In Bluetooth connection mode, the Bluetooth connection will be lost if the distance between the Soundbar and the Bluetooth device exceeds 10 meters.
- The Soundbar automatically turns off after 18 minutes in the Ready state.
- The Soundbar may not perform Bluetooth search or connection correctly under the following circumstances:
 - If there is a strong electrical field around the Soundbar.
 - If several Bluetooth devices are simultaneously paired with the Soundbar.
 - If the Bluetooth device is turned off, not in place, or malfunctions.
- Electronic devices may cause radio interference. Devices that generate electromagnetic waves must be kept away from the Soundbar main unit - e.g., microwaves, wireless LAN devices, etc.

Connecting via Wi-Fi

Pre-connection Checklist

1. Confirm that your **Samsung Smart TV was released after 2013**. This function is compatible only with Samsung Smart TVs released after 2013.
2. Make sure your **Wireless router (Wi-Fi)** is ready and working.
3. Make sure that the **TV is connected to the Wireless router (your Wi-Fi network)**.

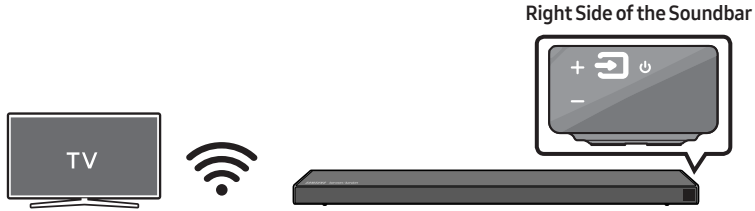

Step 1 : Connecting the Soundbar to Wi-Fi

1. Press the  (**Source**) button on the right side of the Soundbar or on the remote control to select "**WIFI**" mode.
 - When using selected Samsung TVs (2016 ~ 2018 Samsung Smart TVs that support Bluetooth.)
 - If you select "**WIFI**" mode when the TV is turned on, the TV screen displays a pop-up window providing instructions on how to automatically connect the Soundbar to a wireless router (Wi-Fi). Refer to the instructions in the pop-up window of the TV.

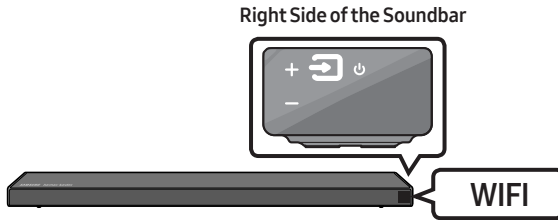

2. Connect your mobile device (smartphone, tablet, etc.) to the Wi-Fi network the TV is connected to.

3. Install and launch the **SmartThings** app on your mobile device (smartphone, tablet, etc.).



4. Follow the instructions in the app screen on the mobile device to connect the Soundbar to your Wi-Fi network.

Step 2 : Configuring Settings on the TV

- If the TV disconnects from your wireless network after you change the input source to the Soundbar, use the TV menu to connect the TV to the network again.

For TVs released in 2019

Home (🏠) → Settings (⚙️) → Sound → Sound Output → [AV] Samsung Soundbar Q70R (Wi-Fi)

For TVs released in 2018

Home (🏠) → Settings (⚙️) → Sound → Sound Output → [AV] Samsung Soundbar Q70R (Wi-Fi)

For TVs released in 2017

Home (🏠) → Settings (⚙️) → Sound → Sound Output → [AV] Samsung Soundbar Q70R (Wi-Fi)

For TVs released in 2016

Home (🏠) → Settings (⚙️) → Sound → Select Speaker → [AV] Samsung Soundbar Q70R (Wi-Fi)

For TVs released in 2015

Menu → Sound → Speaker List

For TVs released in 2014

Menu → Sound → Speaker Settings → Multiroom Link - Settings

NOTES

- The TV and Soundbar must be connected to the same wireless network (Wi-Fi).
- If your wireless router (Wi-Fi) uses a DFS channel, you will not be able to establish a Wi-Fi connection between the TV and Soundbar. Contact your Internet service provider for details.
- If the 5GHz Wi-Fi connection is not smooth, use the 2.4GHz bandwidth.
- Because the menus may differ depending on the year of manufacture, refer to your TV manual.

05 CONNECTING AN EXTERNAL DEVICE

Connect to an external device via a wired or wireless network to play the external device's sound through the Soundbar.

Connecting using an HDMI Cable (Capable of Dolby Atmos decoding and playback)

- **When you use Dolby Atmos®:** If the input source is Dolby Atmos®, 3.1.2 channels are outputted. When Dolby Atmos® is active, the Soundbar's sound effect modes controlled by the **SOUND MODE** button are not available.
- **Important:** This product supports Dolby Atmos® only in HDMI mode.

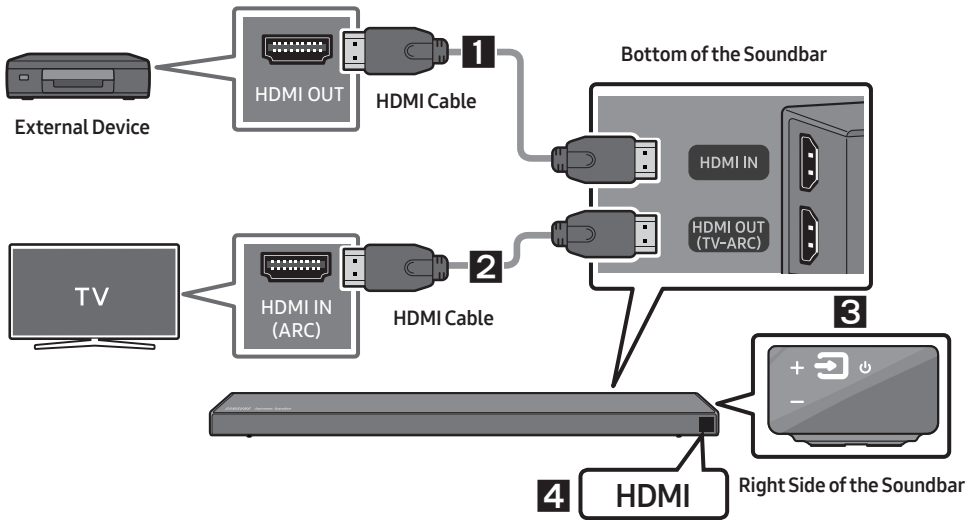

1. Connect an HDMI cable from the **HDMI IN** jack on the back of the product to the HDMI OUT jack on your digital device.
2. Connect an HDMI cable from the **HDMI OUT (TV-ARC)** jack on the back of the product to the HDMI IN jack on your TV.
3. Press the  (**Source**) button on the right side panel or on the remote control, and then select "HDMI".
4. "HDMI" mode is displayed on the Soundbar display panel and sound plays.

NOTE

- When Dolby Atmos® is activated, "DOLBY ATMOS" appears in the front display.

Configuring Dolby Atmos® on your BD player or other device.

- Open the audio output options on the settings menu of your BD player or other device and make sure that “No Encoding” is selected for Bitstream. For example, on a Samsung BD Player, go to Home Menu → Sound → Digital Output and then select Bitstream (unprocessed).
- If the Audio Output options include Secondary Audio, make sure Secondary Audio is set to Off.
- Make sure that the content supports Dolby Atmos®.

Connecting using an HDMI Cable

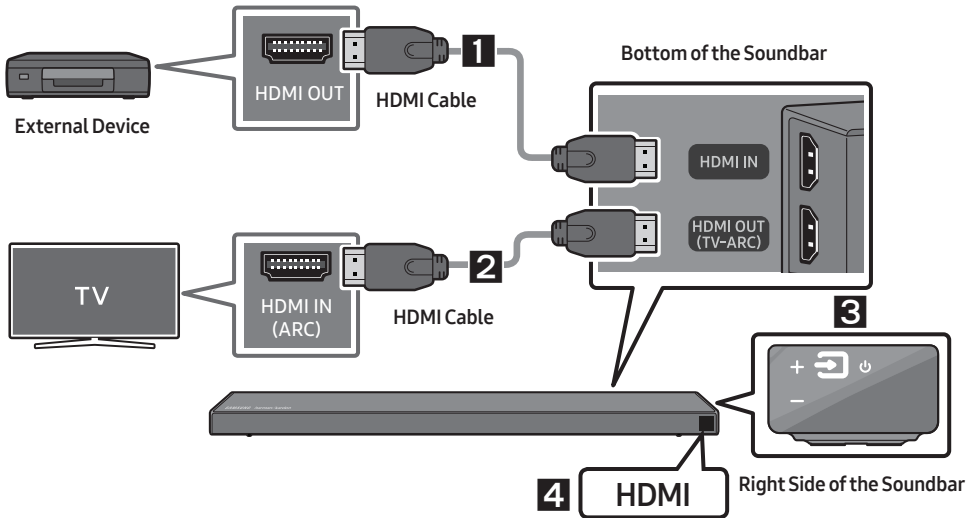

1. Connect an HDMI cable from the **HDMI IN** jack on the back of the product to the HDMI OUT jack on your digital device.
2. Connect an HDMI cable from the **HDMI OUT (TV-ARC)** jack on the back of the product to the HDMI IN jack on your TV.
3. Press the  (**Source**) button on the right side panel or on the remote control, and then select “HDMI”.
4. “HDMI” mode is displayed on the Soundbar display panel and sound plays.

Connecting using an Optical Cable

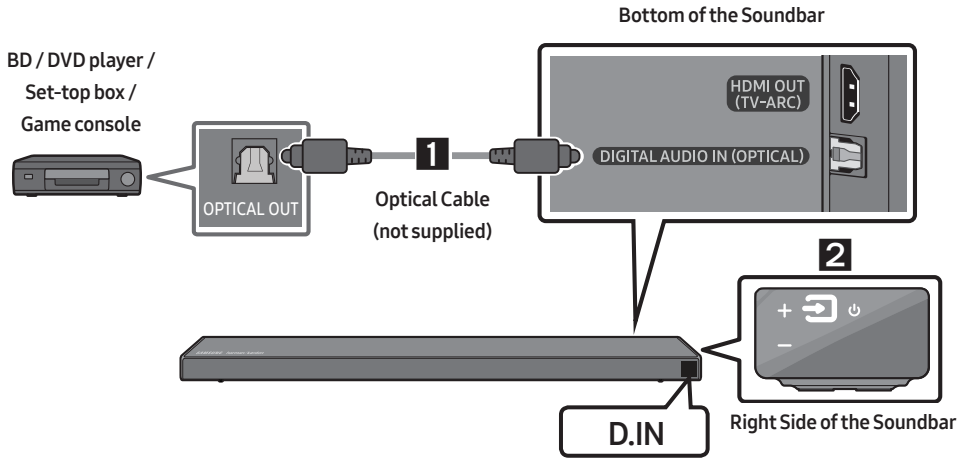

1. Connect **DIGITAL AUDIO IN (OPTICAL)** on the main unit to the **OPTICAL OUT** jack of the Source Device using a digital optical cable (not supplied).
2. Select “**D.IN**” mode by pressing the  (**Source**) button on the right side panel or on the remote control.

06 CONNECTING A MOBILE DEVICE

Connecting via Bluetooth

When a mobile device is connected using Bluetooth, you can hear stereo sound without the hassle of cabling.

- You cannot connect more than one Bluetooth device at a time.

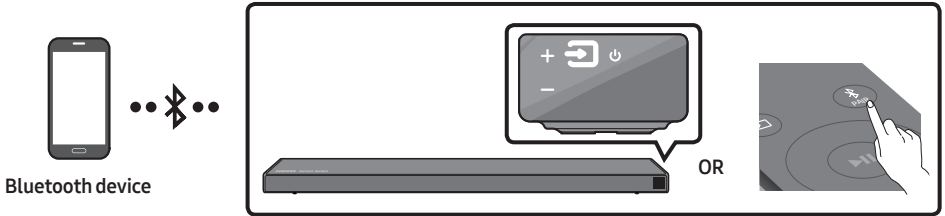

The initial connection

1. Press the **PAIR** button on the remote control to enter the **"BT PAIRING"** mode.
(OR) a. Press the **Source** button on the right side panel and then select **"BT"**.
"BT" changes to **"BT READY"** in a few seconds automatically if there is no Bluetooth device connected to the Soundbar.
b. When **"BT READY"** appears, press and hold the **Source** button on the right side panel of the Soundbar for more than 5 seconds to display **"BT PAIRING"**.
2. On your device, select **"[AV] Samsung Soundbar Q70R"** from the list that appears.
 - When the Soundbar is connected to the Bluetooth device, **[Bluetooth Device Name]** → **"BT"** appears in the front display.
3. Play music files from the device connected via Bluetooth through the Soundbar.



If the device fails to connect

- If a previously connected Soundbar (e.g. **"[AV] Samsung Soundbar Q70R"**) appears in the list, delete it.
- Then repeat steps 1 and 2.

NOTE

- After you have connected the Soundbar to your mobile device the first time, use the **"BT READY"** mode to reconnect.

What is the difference between BT READY and BT PAIRING?

- **BT READY** : In this mode, you can search for previously connected TVs or connect a previously connected mobile device to the Soundbar.
- **BT PAIRING** : In this mode, you can connect a new device to the Soundbar. (Press the  **PAIR** button on the remote control or press and hold the  (**Source**) button on the right side of the Soundbar for more than 5 seconds while the Soundbar is in "BT" mode.)

NOTES

- If asked for a PIN code when connecting a Bluetooth device, enter <0000>.
- In Bluetooth connection mode, the Bluetooth connection will be lost if the distance between the Soundbar and the Bluetooth device exceeds 10 meters.
- The Soundbar automatically turns off after 18 minutes in the Ready state.
- The Soundbar may not perform Bluetooth search or connection correctly under the following circumstances:
 - If there is a strong electrical field around the Soundbar.
 - If several Bluetooth devices are simultaneously paired with the Soundbar.
 - If the Bluetooth device is turned off, not in place, or malfunctions.
- Electronic devices may cause radio interference. Devices that generate electromagnetic waves must be kept away from the Soundbar main unit - e.g., microwaves, wireless LAN devices, etc.
- The Soundbar supports SBC data (44.1kHz, 48kHz).
- Connect only to a Bluetooth device that supports the A2DP (AV) function.
- You cannot connect the Soundbar to a Bluetooth device that supports only the HF (Hands Free) function.
- Once you have paired the Soundbar to a Bluetooth device, selecting "[AV] Samsung Soundbar Q70R" from the device's scanned devices list will automatically change the Soundbar to "BT" mode.
 - Available only if the Soundbar is listed among the Bluetooth device's paired devices.
(The Bluetooth device and the Soundbar must have been previously paired at least once.)
- The Soundbar will appear in the Bluetooth device's searched devices list only when the Soundbar is displaying "BT READY".
- The Soundbar cannot be paired to another Bluetooth device if already in Bluetooth mode and paired to a Bluetooth device.

Disconnecting the Bluetooth device from a Soundbar

You can disconnect a Bluetooth device from the Soundbar. For instructions, see the Bluetooth device's user manual.

- The Soundbar will be disconnected.
- When the Soundbar is disconnected from the Bluetooth device, the Soundbar will display **"BT DISCONNECTED"** on the front display.

Disconnecting the Soundbar from the Bluetooth device

Press the  (**Source**) button on the right side panel or on the remote control, and then change to any mode except **"BT"**.

- Disconnecting takes time because the Bluetooth device must receive a response from the Soundbar. (Disconnection time may differ, depending on the Bluetooth device)
- When the Soundbar is disconnected from the Bluetooth device, the Soundbar will display **"BT DISCONNECTED"** on the front display.

NOTES

- In Bluetooth connection mode, the Bluetooth connection will be lost if the distance between the Soundbar and the Bluetooth device exceeds 10 meters.
- The Soundbar automatically turns off after 18 minutes in the Ready state.

More About Bluetooth

Bluetooth is a technology that enables Bluetooth-compliant devices to interconnect easily with each other using a short wireless connection.

- A Bluetooth device may cause noise or malfunction, depending on usage, if:
 - A part of your body is in contact with the receiving/transmitting system of the Bluetooth device or the Soundbar.
 - It is subject to electrical variation from obstructions caused by a wall, corner, or office partition.
 - It is exposed to electrical interference from same frequency-band devices including medical equipment, microwave ovens, and wireless LANs.
- Pair the Soundbar with the Bluetooth device while they are close together.
- The further the distance between the Soundbar and Bluetooth device, the worse the quality is. If the distance exceeds the Bluetooth operational range, the connection is lost.
- In poor reception areas, the Bluetooth connection may not work properly.
- The Bluetooth connection only works when it is close to the unit. The connection will be automatically cut off if the Bluetooth device is out of range. Even within range, the sound quality may be degraded by obstacles such as walls or doors.
- This wireless device may cause electric interference during its operation.

Connecting via Wi-Fi (Wireless Network)

- Connect a single Soundbar to Wi-Fi to access a variety of music streaming services and Internet radio. Connect multiple Soundbars to Wi-Fi to use grouped playback or the stereo sound mode.
- To connect a Soundbar to a mobile device via a wireless network (Wi-Fi), the **SmartThings** app is required.



The initial connection

1. Press the  (**Source**) button on the right side of the Soundbar or on the remote control to select "WIFI" mode.

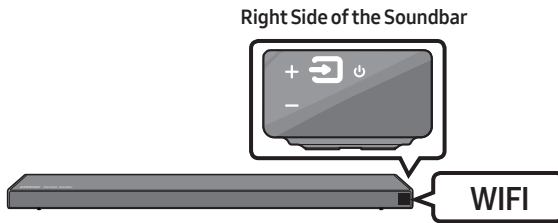

2. Install and launch the **SmartThings** app on your mobile device (e.g. smartphone or tablet).

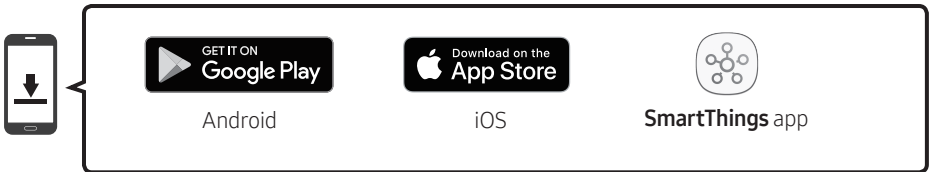

3. Launch the app, and then follow the instructions on the screen to register (add) your Soundbar in the app.
- The automatic pop-up (the third illustration below) may not be available on some mobile devices.
- If this is the case, select and complete “**Add device**” from the app menu . Your Soundbar is now added to the app.

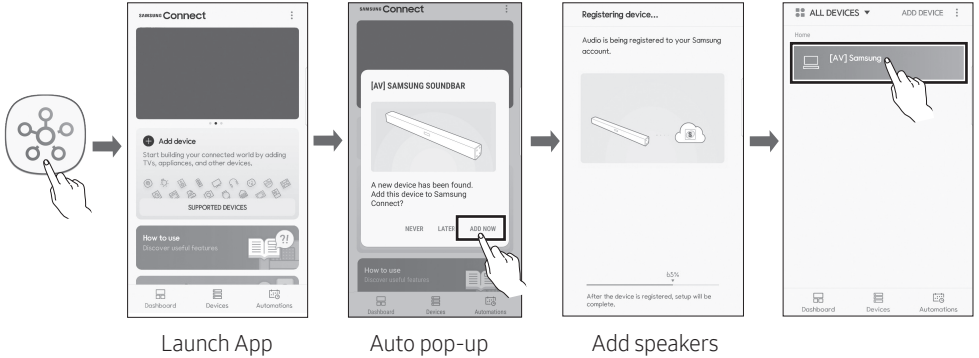

NOTE

- To connect an additional SWA-8500S wireless rear speaker kit (not supplied), disconnect the Samsung wireless speakers from the Soundbar to disable the surround sound system. (If you connect the surround speakers without disconnecting the SWA-8500S speakers, sound is played via both the Samsung wireless speaker and the Surround speaker.)

07 CONNECTING AN AMAZON PRODUCT

- This feature may not be available in some countries.
- This service is provided by Amazon and can be terminated at any time. Samsung does not assume responsibility for service availability.
- **Amazon Alexa** app screen is subject to change without prior notice.

Connect and use with an Amazon product (Amazon Echo)

Use an Amazon Echo product to control your Soundbar and enjoy music services provided by Amazon Echo.

NOTE

- Confirm that the Soundbar is connected to Wi-Fi. (Refer to “Connecting via Wi-Fi (Wireless Network)”)

1. In the **SmartThings** app, change your Soundbar’s name to one that can be recognized by your Amazon device.
(Example: Samsung, Soundbar, Living Room, Family Room, Bedroom, Office, etc.)

CAUTION

- Amazon devices may not recognize names that contain elements such as special characters.

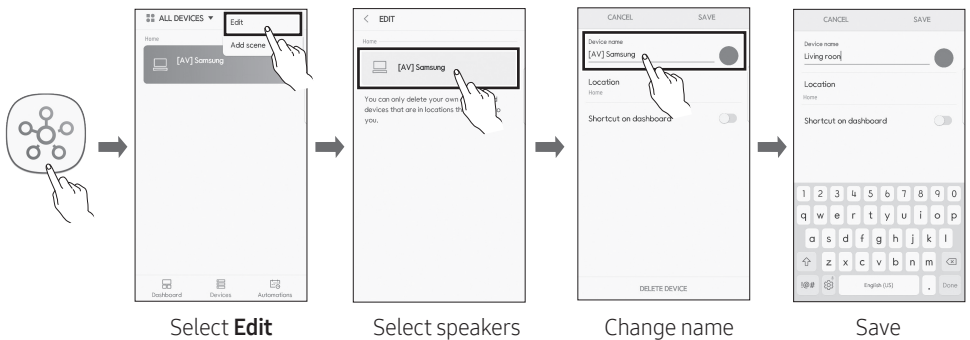

2. In the **Alexa** app, search “**Samsung Wireless Audio**” in **Skills**, and then select “**ENABLE**”.

- Skip this step if you have **Skills** set up already.

Amazon Alexa app

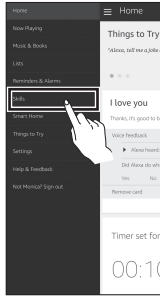

Select **Skills**

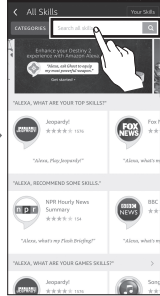

Search

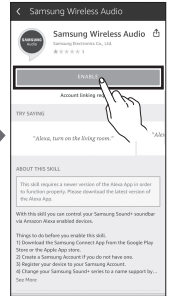

Enable

Use voice commands to control the Soundbar

- The Amazon Echo service you can use with your Soundbar is limited to music. Other services provided by Amazon Echo, such as news and weather, can only be accessed through your Amazon Echo product.



Trigger + Command + Speaker name

Use the Speaker name you changed in the SmartThings app. (Refer to “Connect and use with an Amazon product (Amazon Echo)”)

Action	Voice Command
To search an audio device added to the SmartThings account connected to the Amazon Alexa account	"Alexa Discover devices"







* To use voice commands for the Soundbar named “Living room”

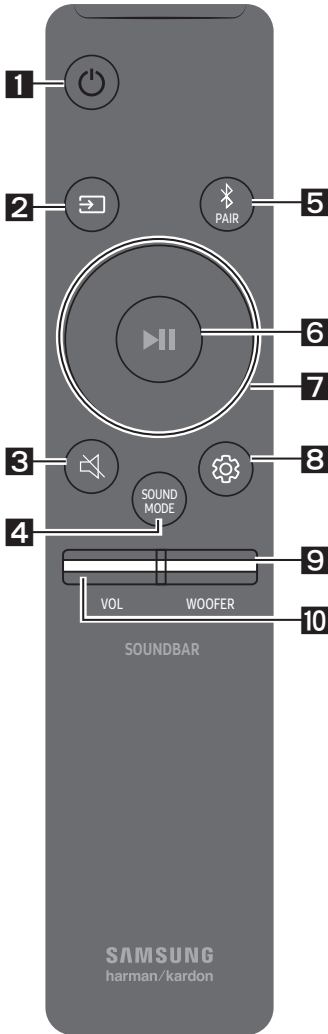

Action	Voice Command
To set the volume level to 5	"Alexa Set the volume to 5 on Living room"
To increase the volume level	"Alexa Volume up on Living room"
To mute the sound	"Alexa Mute on Living room"
To listen to a radio station named KISS FM	"Alexa Play Kiss FM on Living room"
To play the next song	"Alexa Next song on Living room"
To stop the audio	"Alexa Stop on Living room"
To turn the audio on	"Alexa Turn on Living room"
To turn the audio off	"Alexa Turn off Living room"
To change the input source	"Alexa Switch to Bluetooth on Living room"







08 USING THE REMOTE CONTROL

How to Use the Remote Control

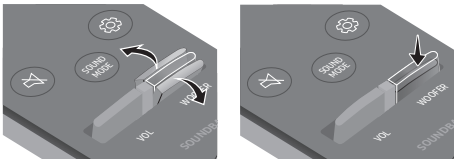

<p>1</p>	 Power	<p>Turns the Soundbar on and off.</p>
<p>2</p>	 Source	<p>Press to select a source connected to the Soundbar.</p>
<p>3</p>	 Mute	<p>Press the  (Mute) button to mute the sound. Press it again to unmute the sound.</p>
<p>4</p>	 SOUND MODE	<p>You can select the desired sound mode by choosing STANDARD, SURROUND, GAME PRO, or ADAPTIVE SOUND. Select the “STANDARD” mode if you want to enjoy the original sound.</p> <ul style="list-style-type: none"> • GAME PRO mode Immerse yourself in the scene with a dedicated setting that optimizes sounds specifically for gaming. • ADAPTIVE SOUND mode Automatically analyzes content and gives you optimized sound and automatically enhances voice clarity on low volumes.
<p>5</p>	 Bluetooth PAIR	<p>Press the  PAIR button. “BT PAIRING” appears in the Soundbar’s display. You can connect the Soundbar to a new Bluetooth device in this mode by selecting the Soundbar from the Bluetooth device’s search list.</p>

<p>6</p>	 <p>Play / Pause (BT/Wi-Fi)</p>	<p>Press the ► button to pause a music file temporarily. When you press the button again, the music file plays.</p>
<p>7</p>	 <p>Up/Down/ Left/Right</p>	 <p>Press the indicated areas to select Up/Down/Left/Right.</p> <p>Press Up/Down/Left/Right on the button to select or set functions.</p> <ul style="list-style-type: none"> • Music Skip Press the Right button to select the next music file. Press the Left button to select the previous music file. • Anynet+ / Auto Power Link You can turn Anynet+ and Auto Power Link on or off. Anynet+ and Auto Power Link are turned on and turned off by the Right and Left buttons respectively. <ul style="list-style-type: none"> – Anynet+ : If the Soundbar is connected to a Samsung TV through an HDMI cable, you can control your Soundbar with a Samsung TV remote control. Press and hold the Right button for 5 seconds to toggle Anynet+ ON and OFF. – Auto Power Link : If the Soundbar is connected to your TV through a digital optical cable, the Soundbar can automatically turn on when you turn on your TV. Press and hold the Left button for 5 seconds to toggle Auto Power Link ON and OFF. – Anynet+ / Auto Power Link are set to ON by default. • ID SET Press and hold the Up button for 5 seconds to complete ID SET (when connecting to an accessory item).

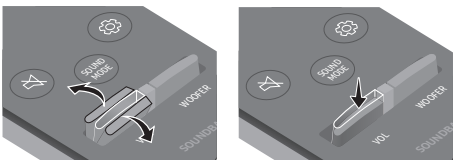
<p>8</p>	 <p>Sound Control</p>	<p>You can select TREBLE, BASS, SYNC, CENTER LEVEL, SIDE LEVEL, FRONT TOP LEVEL, REAR LEVEL, and VIRTUAL ON/OFF.</p> <ul style="list-style-type: none"> - To control the volume of the treble or bass sound, select TREBLE or BASS in Sound Settings, and then adjust the volume between -6~+6 by using the Up/Down buttons. - Press and hold the  (Sound Control) button for about 5 seconds to adjust the sound for each frequency band. 150Hz, 300Hz, 600Hz, 1.2kHz, 2.5kHz, 5kHz, and 10kHz are selectable using the Left/Right buttons and each can be adjusted to a setting between -6 to +6 using the Up/Down buttons. - To control the volume of the each speaker select CENTER LEVEL, SIDE LEVEL or FRONT TOP LEVEL in Sound Settings, and then adjust the volume between -6~+6 by using the Up/Down buttons. - If the video on the TV and audio from the Soundbar are not synchronised, select SYNC in Sound Control, and then set the audio delay between 0~300 milliseconds by using the Up/Down buttons. - If Surround Speakers are connected, select REAR LEVEL and then use the Up/Down buttons to adjust the volume within a -6 to +6 range. The VIRTUAL Speaker function can be turned ON/OFF by using the Up/Down buttons. - SYNC is only supported for some functions. <ul style="list-style-type: none"> • Initialise With the Soundbar turned off, press and hold the  (Sound Control) button for more than 5 seconds until the speaker turns on. "INIT" appears on the display and the Soundbar is initialised.
<p>9</p>	 <p>WOOFER</p>	 <p>Push the button up or down to adjust the volume of the subwoofer to -12 or between -6 to +6. To set the subwoofer volume level to 0, press the button.</p>
<p>10</p>	 <p>VOL</p>	 <p>Push the button up or down to adjust the volume.</p> <ul style="list-style-type: none"> • Mute Press the VOL button to mute the sound. Press it again to unmute the sound.

Adjusting the Soundbar volume with a TV remote control

If you have a Samsung TV, you can adjust the Soundbar's volume using the IR remote control that came with your Samsung TV.

First use the TV menu to set the TV audio on your Samsung TV to external speakers, then use your Samsung remote to control the Soundbar's volume. For more information, see the TV's user manual. The default mode for this function is control by a Samsung TV remote. If your TV is not a Samsung TV, follow the directions below to change the settings of this function.

1. Turn Off the Soundbar.

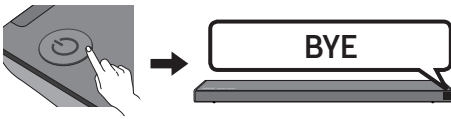

2. If you do not want to use this function, push up and hold the **WOOFER** button for 5 seconds repeatedly until "**OFF-TV REMOTE**" appears in the display.

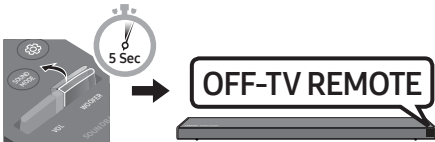

3. If you want to control the Soundbar with your TV's remote, push up and hold the **WOOFER** button for 5 seconds repeatedly until "**ALL-TV REMOTE**" appears in the display. Then, use your TV's menu to select external speakers.



4. If you want to return the Soundbar to the default mode (control by a Samsung TV remote), push up and hold the **WOOFER** button for 5 seconds repeatedly until "**SAMSUNG-TV REMOTE**" appears in the display.

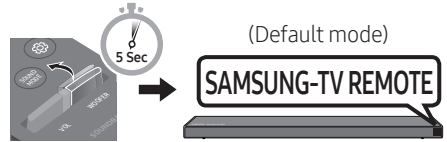

- Each time you push the **WOOFER** button up and hold it for 5 seconds, the mode switches in the following order:
"**SAMSUNG-TV REMOTE**" (Default mode) → "**OFF-TV REMOTE**" → "**ALL-TV REMOTE**".
- This function may not be available, depending on the remote control.
- Manufacturers supporting this function: VIZIO, LG, Sony, Sharp, PHILIPS, PANASONIC, TOSHIBA, GRUNDIG, Hisense, RCA

Using the Hidden Buttons (Buttons with more than one function)

Hidden Button		Reference page
Remote Control Button	Function	
WOOFER	TV remote control On/Off (Standby)	page 30
Left	Auto Power Link ON/OFF	page 28
Right	Anynet+ ON/OFF	page 28
Up	ID SET	page 28
 (Sound Control)	7 Band EQ	page 29
	Initialise (Standby)	page 29

Output specifications for the different sound effect modes

Effect	Input	Output	
		With Subwoofer Only	With Subwoofer & Wireless Rear Speaker Kit
STANDARD	2.0 ch	2.1 ch	2.1 ch
	5.1 ch	3.1 ch	5.1 ch
SURROUND	2.0 ch	3.1.2 ch	5.1.2 ch
	5.1 ch	3.1.2 ch	5.1.2 ch
GAME PRO	2.0 ch	3.1.2 ch	5.1.2 ch
	5.1 ch	3.1.2 ch	5.1.2 ch
ADAPTIVE SOUND	2.0 ch	3.1.2 ch	5.1.2 ch
	5.1 ch	3.1.2 ch	5.1.2 ch

- If the input source is Dolby Atmos®, 3.1.2 channels are outputted. The sound effect modes controlled by the **SOUND MODE** button and listed above are not available.
- The Samsung Wireless Rear Speaker Kit can be purchased separately. To purchase a Kit, contact the vendor you purchased the Soundbar from.

09 INSTALLING THE WALL MOUNT

Wallmount Components

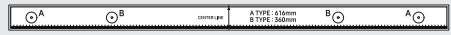

Wall Mount Guide



x 2

Holder-Screw



x 2

Screw



x 2

Bracket-Wall Mount

Installation Precautions

- Install on a vertical wall only.
- Do not install in a place with high temperature or humidity.
- Verify whether the wall is strong enough to support the product's weight. If not, reinforce the wall or choose another installation point.
- Purchase and use the fixing screws or anchors appropriate for the kind of wall you have (plaster board, iron board, wood, etc.). If possible, fix the support screws into wall studs.
- Purchase wall mounting screws according to the type and thickness of the wall you want to mount the Soundbar on.
 - Diameter: M5
 - Length: 35 mm or longer recommended.
- Connect cables from the unit to external devices before you install the Soundbar on the wall.
- Make sure the unit is turned off and unplugged before you install it. Otherwise, it may cause an electric shock.

1. Place the **Wall Mount Guide** against the wall surface.
 - The **Wall Mount Guide** must be level.
 - If your TV is mounted on the wall, install the Soundbar at least 5 cm below the TV.



TV



5 cm or more

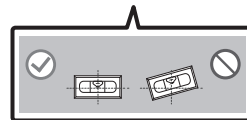

2. Align the **Wall Mount Guide's Centre Line** with the centre of your TV (if you are mounting the Soundbar below your TV), and then fix the **Wall Mount Guide** to the wall using tape.

- If you are not mounting below a TV, place the **Centre Line** in the centre of the installation area.

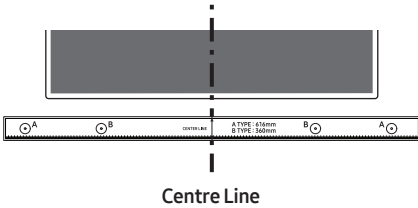

3. Push a pen tip or sharpened pencil tip through the centre of the **A-TYPE** images on each end of the Guide to mark the holes for the supporting screws, and then remove the **Wall Mount Guide**.

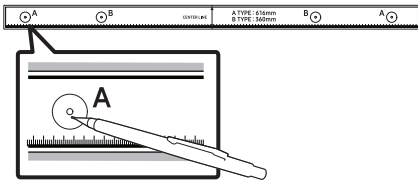

4. Using an appropriately sized drill bit, drill a hole in the wall at each marking.

- If the markings do not correspond to the positions of studs, make sure you insert appropriate anchors or mollies into the holes before you insert the support screws. If you use anchors or mollies, make sure the holes you drill are large enough for the anchors or mollies you use.

5. Push a screw (not supplied) through each **Holder-Screw**, and then screw each screw firmly into a support screw hole.

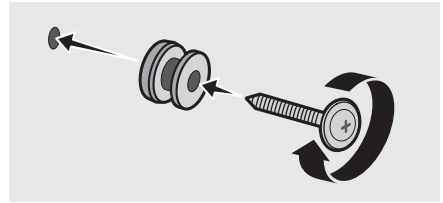

6. Install the 2 **Bracket-Wall Mounts** in the correct orientation on the bottom of the Soundbar using 2 **Screws**.

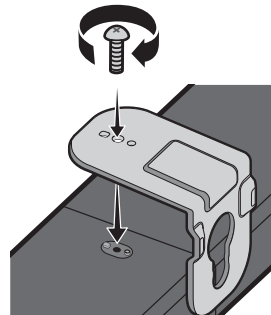

- Remove the **Holder-Feet** and **Holder-Supports** if they are attached.
- When assembling, make sure the hanger part of the **Bracket-Wall Mounts** are located behind the rear of the Soundbar.

Rear of Soundbar

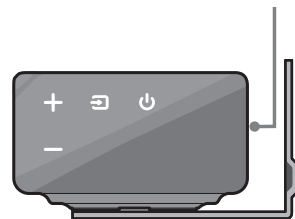

Right end of Soundbar

7. Install the Soundbar with the attached **Bracket-Wall Mounts** by hanging the **Bracket-Wall Mounts** on the **Holder-Screws** on the wall.

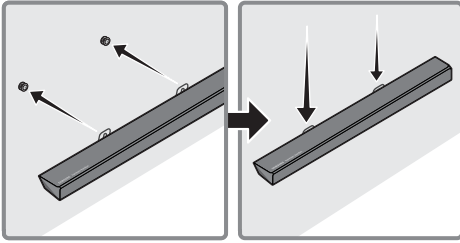

8. Slide the Soundbar down as shown below so that the **Bracket-Wall Mounts** rest securely on the **Holder-Screws**.

- Insert the **Holder-Screws** into the wide (bottom) part of the **Bracket-Wall Mounts**, and then slide the **Bracket-Wall Mounts** down so that the **Bracket-Wall Mounts** rest securely on the **Holder-Screws**.

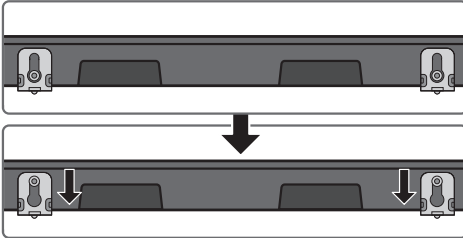

10 INSTALLING THE HOLDER-FEET

Holder-Feet Components

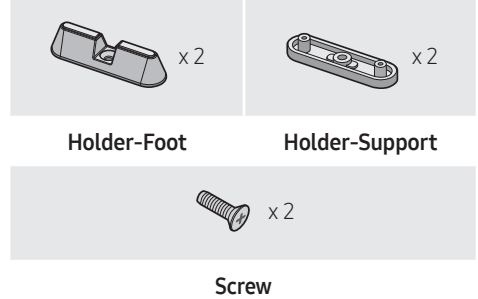

- The **Holder-Feet** raise the Soundbar so you can install the Soundbar in front of your TV and above the legs of the TV's stand. See the illustration below.
- You can set the **Holder-Feet** to one of three different heights.
- Using the **Holder-Feet**, you can adjust the distance between the Soundbar and your TV to fit your TV stand's shape.

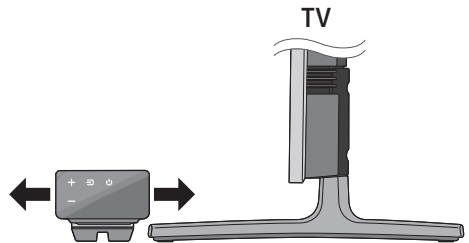

Raising the Soundbar 15 mm

1. Use the 2 supplied **Screws** to fix the two **Holder-Feet** to the wall mount assembly on the bottom panel of the Soundbar.

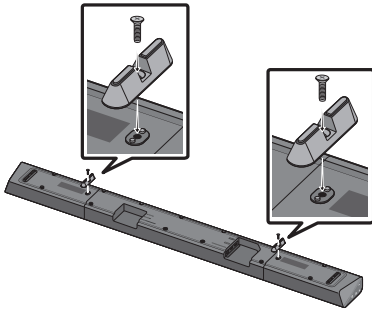

Raising the Soundbar 20 mm

1. Attach the two **Holder-Feet** to the two **Holder-Supports**, as shown in the figure below.

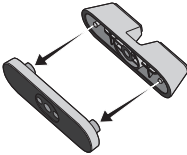

2. Use the 2 supplied **Screws** to fix the two **Holder-Feet** to the Wall Mount assembly on the bottom panel of the Soundbar.

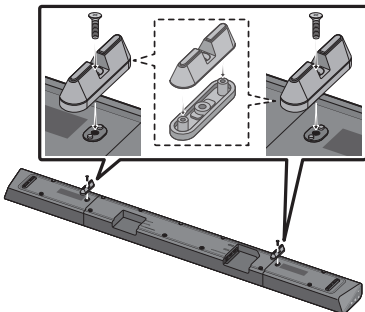

11 SOFTWARE UPDATE

When the Soundbar is connected to the Internet, software updates automatically occur even when the Soundbar is turned off.

- To use the Auto Update function, the Soundbar must be connected to the Internet. The Wi-Fi connection to the Soundbar will be terminated if the Soundbar's power cord is disconnected or the power is cut off. If the power is cut off, when the power comes back on or you reconnect the power cord, turn on the Soundbar, and then reconnect it to the Internet.

12 TROUBLESHOOTING

Before seeking assistance, check the following.

The unit will not turn on.

Is the power cord plugged into the outlet?

- Connect the power plug to the outlet.

A function does not work when the button is pressed.

Is there static electricity in the air?

- Disconnect the power plug and connect it again.

Sound dropouts occur in BT mode.

- See the Bluetooth connection sections on pages 12 and 19.

Sound is not produced.

Is the Mute function on?

- Press the  (Mute) button to cancel the mute function.

Is the volume set to minimum?

- Adjust the Volume.

The remote control does not work.

Are the batteries drained?

- Replace with new batteries.

Is the distance between the remote control and Soundbar main unit too far?

- Move the remote control closer to the Soundbar main unit.

The red LED on the subwoofer blinks and the subwoofer is not producing sound.

This issue can occur if the subwoofer is not connected to the Soundbar main unit.

- Try to connect your subwoofer again.
(See page 6.)

The subwoofer drones and vibrates noticeably.

Try to adjust the vibration of your subwoofer.

- Push the **WOOFER** button on your remote control up or down to adjust the subwoofer volume. (to -12, or between -6 ~ +6).

Cannot connect to the TV.

If connected via a wired network

- Check if the cable is connected correctly.
 - Check the port name to make sure that the cable is connected to the correct port. For instructions, see the page explaining each connection method.

- Press the  (Source) button on the right side panel of the Soundbar or on the remote control to check if the mode is correct.

If connected via a wireless network

→ Connected via Bluetooth

1. Switch the Soundbar to “**BT PAIRING**” mode, and then use the TV to search again. (See page 12 for details.)

→ **Connected via Wi-Fi**

1. Check if the TV is a compatible model.
 - Only **Samsung Smart TVs** released after 2013 are supported.
 2. Check if the TV is connected to Wi-Fi.
 - If the TV is not connected to Wi-Fi, use the network menu on the TV to establish a connection. (See the TV user manual.)
 3. Check if the Soundbar is connected to Wi-Fi.
 - When the Soundbar is connected, you can find it in the list of speakers on your mobile device when you run the **SmartThings** app. See page 22 for details.
 4. Check for a DFS channel.
 - If your wireless router (Wi-Fi) is using a DFS channel, you cannot establish a Wi-Fi connection between the TV and Soundbar. Contact your Internet service provider for details.
-

13 LICENCE



Manufactured under license from Dolby Laboratories. Dolby, Dolby Atmos, Dolby Audio, Dolby Digital Plus, Pro Logic, and the double-D symbol are trademarks of Dolby Laboratories.



For DTS patents, see <http://patents.dts.com>.
Manufactured under license from DTS Licensing Limited. DTS, the Symbol, & DTS and the Symbol together, DTS:X, and the DTS:X logo are registered trademarks and/or trademarks of DTS, Inc. in the United States and/or other countries. © DTS, Inc. All Rights Reserved.



The terms HDMI and HDMI High-Definition Multimedia Interface, and the HDMI Logo are trademarks or registered trademarks of HDMI Licensing LLC in the United States and other countries.



- The Spotify Software is subject to third party licences found here : www.spotify.com/connect/third-party-licences.
 - For more information about Spotify Connect, please visit www.spotify.com/connect
-

14 OPEN SOURCE LICENCE NOTICE

For further information on Open Sources used in this product, please visit the website:

<http://opensource.samsung.com>

15 IMPORTANT NOTES ABOUT SERVICE

Figures and illustrations in this User Manual are provided for reference only and may differ from actual product appearance.

16 SPECIFICATIONS AND GUIDE

Specifications

Model Name	HW-Q70R
Weight	3.6 kg
Dimensions (W x H x D)	1100.0 x 59.0 x 100.0 mm
Operating Temperature Range	+5°C to +35°C
Operating Humidity Range	10 % ~ 75 %
AMPLIFIER	
Rated Output power	30W x 5 + 10W x 2, 6ohm x 4 + 4ohm x 3
Supported play formats	LPCM 8ch, Dolby Digital, Dolby Atmos (True HD / Digital Plus), DTS:X

Subwoofer Name	PS-WR75B
Weight	9.8 kg
Dimensions (W x H x D)	205.0 x 403.0 x 403.0 mm
AMPLIFIER	
Rated Output power	160W

NOTES

- Samsung Electronics Co., Ltd reserves the right to change the specifications without notice.
- Weight and dimensions are approximate.

- **For India Only**

“This product is RoHS compliant”

Precaution : The Soundbar will restart automatically if you turn on/turn off Wi-Fi.

Wi-Fi Port deactivation method	Press at the centre of the WOOFER (or BASS) button on the remote control for 30 seconds or longer to turn the Wi-Fi On / Off.
Bluetooth Port deactivation method	Press the NETWORK button on the bottom panel of the Soundbar for 30 seconds to turn Bluetooth On / Off.



© 2019 Samsung Electronics Co., Ltd. All rights reserved.

Contact SAMSUNG WORLD WIDE

If you have any questions or comments relating to Samsung products, please contact the SAMSUNG customer care Centre.

Area	Contact Centre ☎	Web Site
■ Asia Pacific		
CHINA	400-810-5858	www.samsung.com/cn/support
TAIWAN	0800-329-999	www.samsung.com/tw/support
HONG KONG	3698 4698	www.samsung.com/hk/support (Chinese)
MACAU	0800 333	www.samsung.com/hk_en/support (English)
SINGAPORE	1800 7267864 1800-SAMSUNG	www.samsung.com/sg/support
AUSTRALIA	1300 362 603	www.samsung.com/au/support
NEW ZEALAND	0800 726 786	www.samsung.com/nz/support
VIETNAM	1800 588 889	www.samsung.com/vn/support
THAILAND	0-2689-3232 (OTH products) 1800-29-3232 (Toll free)	www.samsung.com/th/support
MYANMAR	+95-1-2399-888	www.samsung.com/mm/support
CAMBODIA	+855-23-993232 1800-20-3232 (Toll free)	www.samsung.com/th/support
LAOS	+856-214-17333	
MALAYSIA	1800-88-9999 +603-77137420 (Overseas contact)	www.samsung.com/my/support
INDONESIA	021-5699-7777 0800-112-8888 (Toll Free)	www.samsung.com/id/support
PHILIPPINES	1-800-10-726-7864 [PLDT Toll Free] 1-800-8-726-7864 [Globe Landline and Mobile] 02-422-2111 [Standard Landline]	www.samsung.com/ph/support
INDIA	1800 40 SAMSUNG (1800 40 7267864) (Toll-Free)	
NEPAL	16600172667 (Toll Free for NTC Only) 9801572667	
BANGLADESH	09612300300 08000300300 (Toll free)	www.samsung.com/in/support
SRI LANKA	+9411SAMSUNG (+94117267864) +94117540540 +94115900000	